

HAUTEUR TOTALE	PANNEAU MESURE	ENTRE POTEAUX	CENTRE/ CENTRE
24-72	96 ½"	100 ½"	103 ½"
84+	67 ½"	71"	74"

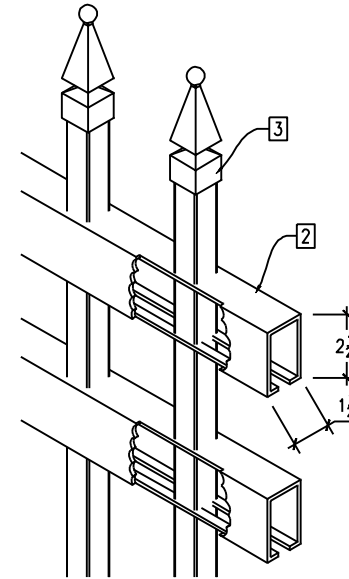

NOTES:

1. POTEAUX 3" x 3" 14 GAUGE.
POST 3" X 3" GALVALUME 14 GAUGE.
2. TRAVERSE DE RAIL PERFORÉE 14 GAUGE
2 ½" x 1 ½" GALV.
RAIL 2 ½" X 1 ½" PIERCE RAILING GALVALUME 14 GAUGE.
3. BARROTINS 1" x 1" 18 GAUGE GALV.
VERTICAL PICKETS 1" X 1" GALVALUME 18 GAUGE.
4. SOUDURE STAINLESS
STAINLESS STEEL WELD.
5. SYSTÈME D'ATTACHE OASIS GALV.
(FERRURE)
OASIS FENCE FITTING SYSTEM GALVALUME
6. REVÊTEMENT DE POUDRE POLYESTER
POLYESTER POWDER COATING.
7. CUISSON AU FOUR
OVEN BAKED

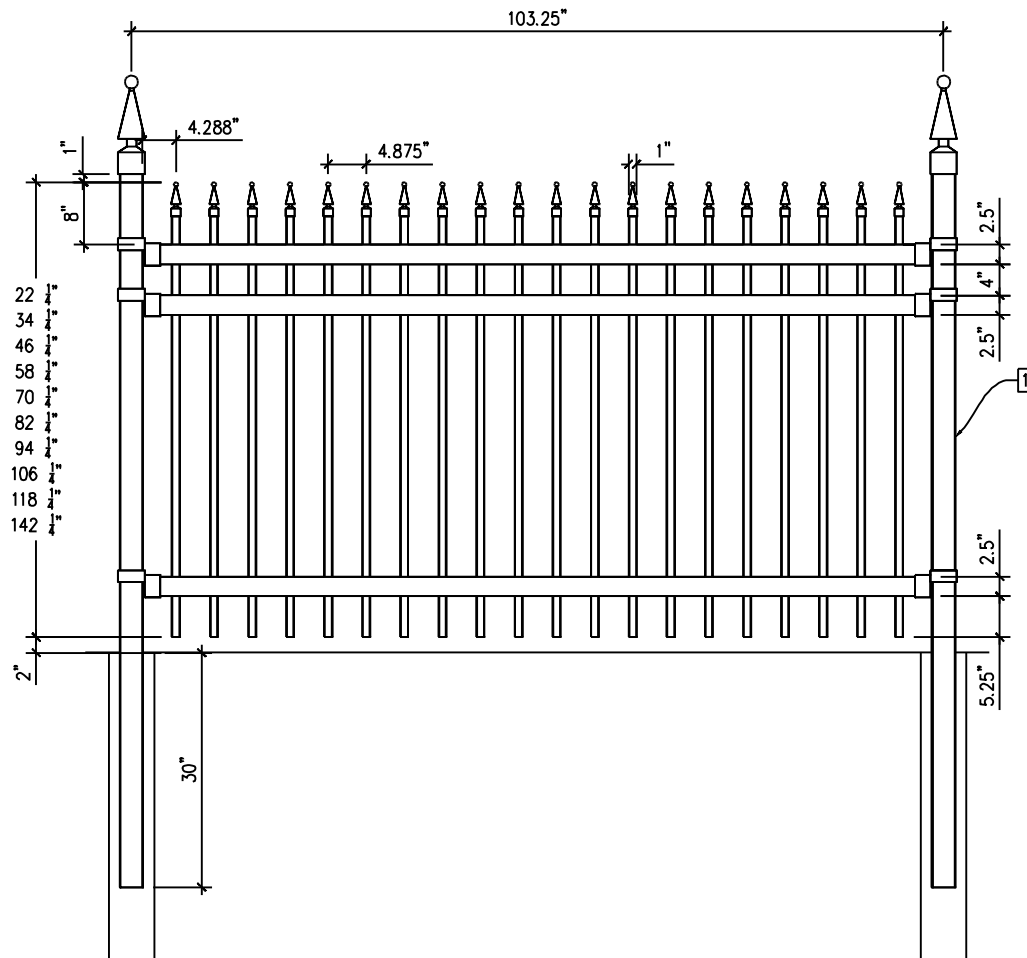

209, rue St-Jean
Lachute, (Québec) J8H 3R8
Tél.: (450) 562-4780
Fax: (450) 562-8161

Projet: DESSIN TECHNIQUE
PROJECT: TECHNICAL DRAWING

Titre: CLÔTURE OASIS / OASIS FENCE
TITLE: SERIE 9000, MODÈLE 9806

Échelle : AUCUNE	Dessiné par : C.M.	Date: 2019-05-09	No.
---------------------	-----------------------	---------------------	-----